

# **A300-1 MASSAGE CHAIR**

Operation Instructions

**SAVE THESE INSTRUCTIONS**

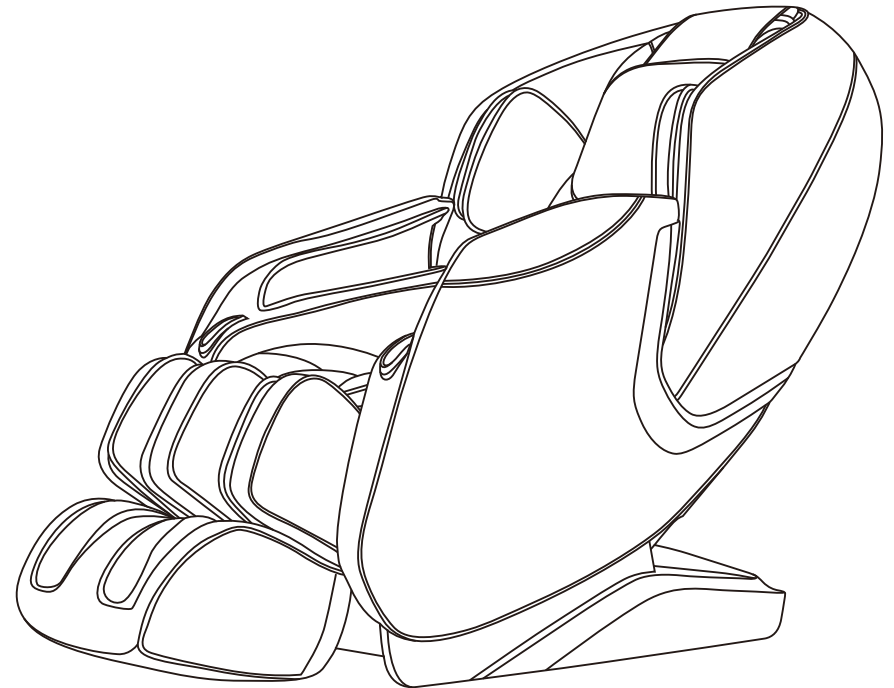

Thanks for purchasing this product. Please read this manual instruction carefully in order to know how to use this product correctly before operation. Please pay more attention to some important safety warning and keep this manual book properly for future use.

Note: Our Company reserves the right to revise the design and description of this product without any further notice. Please refer to the actual color of this product.

## **CONTENTS**

---

Safety and maintenance	02
Safety warning	04
Name and function of components	06
Function	07
Method of usage	08
Product specification	16

## Safety and maintenance

---

### 1. Important Safety Warning.



- Don't allow children to touch moveable part of this product.
- Please use well-grounding power supply suited to this product.
- Please pull out the plug after use or before cleaning to avoid injury or Damage to the product.
- Please operate this product according to this manual instruction.
- Don't use accessories which are not recommended.
- Don't use this product outdoors.
- Please read this manual instruction carefully before operation.
- Any other usage that is not listed in this manual instruction is forbidden.
- 20 minutes of usage each time is recommended.
- Please don't use it if the leather is broken or damaged.
- Please don't use it if the cover or leather is damaged.
- Please don't use it if the radiator hole is covered or blocked.
- Please don't drop anything into this product.
- Please don't fall asleep while using this product.
- Please don't use it if drunk or feel unwell.
- Please don't use it within one hour after having meal.
- Please don't make the massage function too strong for avoiding Injury.

### 2. Environment for usage.

- Please don't use it under high temperature and moist environment such as bathroom.
- Please don't use it immediately while the environmental temperature changes sharply.
- Please don't use it under heavy-dusty or caustic environment.
- Please don't use it where there is not enough space or not good ventilation.

### 3. People who are not suitable to use this product.

- People who are suffering from osteoporosis are not suitable to use this product.
- People who are suffering from heart disease or carrying electronic medical equipment such as heart pacemaker are not suitable to use this product.
- People who are suffering from fever are not suitable to use this product.
- Pregnant women or women that are in menses period are not suitable to use this product.
- People who got injured or skin disease are not suitable to use this product.
- Children under 14-year old or people mentally unbalanced without being Supervised are not allowed to use this machine.
- People who are told by doctor to have rest or people who feel unwell are not suitable to use this product.
- People whose bodies are wet are forbidden to use this product.
- The appliance has a heated surface. Persons insensitive to heat must be careful when using the appliance.

### 4. Safety.

- Check the voltage if it is suitable to the specification of this product.
- Don't use wet hand to pull the plug.
- Don't make water go inside this product to avoid electric shock or cause damage to this product.

## Safety and maintenance

---

- Don't damage the wires or change the circuit of this product.
- Don't use wet cloth to clean the electric parts such as switch and plug.
- Be away from this product under power cut state to avoid injury if the power comeback suddenly.
- Stop using this product while it works abnormal, and please consult local agent immediately.
- Stop using this product if you feel unwell, and please consult health care doctor.
- This appliance is not intended for use by persons (including children) with reduced physical, sensory or mental capabilities, or lack of experience and knowledge, unless they have been given supervision or instruction concerning use of the appliance by a person responsible for their safety.
- Children should be supervised to ensure that they do not play with the appliance.
- If the supply cord is damaged, it must be replaced by the manufacturer, its Service agent or similarly qualified persons in order to avoid a hazard.

### 5. Maintenance.

- This product should be maintained by certain appointed agents, users are prohibited to disassemble or maintain by themselves.
- Please don't forget to cut the power after usage.
- Don't use this product if the socket looses.
- If this product will be left unused for long, please curl up the wires and reserve this product in dry and dustless environment.
- Don't reserve this product under high temperature or near fire and avoid longtime direct sunshine.
- If the detachable cord / supply cord is damaged, it must be replaced by the manufacturer, its service agent or similarly qualified persons in order to avoid a Hazard.
- Please clean this product by dry cloth. Don't use thinner, benzene or alcohol.
- The mechanical components of this product are specially designed and made, it is not necessary to be specially maintained.
- Don't use edged res to thrust this product.
- Don't roll or pull this product above uneven ground, it should be lifted before moving.
- Please use it intermittently; don't make this product work continuously for long.

### 6. Solution of ordinary malfunctions.

- It is nature movement voice if the motor sounds while in usage.
- If the controller can't work normally, please check the plug and socket if they are connected strongly and make sure the switch is turned on.
- If the rated working time is over, the product will automatically activate the power-off button; If this product works continuously for long, the temperature protector will make the product automatically power-off, it should be used again after half an hour's rest.

## Safety warning

### ⚠ Warning

When the footrest lifting, people should not apply pressure on the footrest to avoid the massage chair falling forward to damage the product or cause personal injuries.

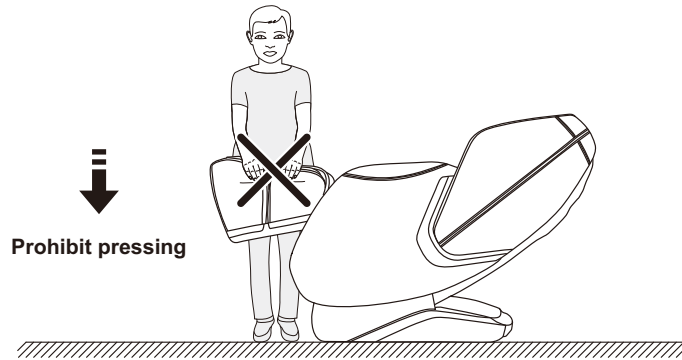

### ⚠ Warning

Before sitting on the massage chair, make sure that the massage hand stays in the seat cushion position to avoid discomfort to the buttocks during the body pressing down and damage to the massage hand.

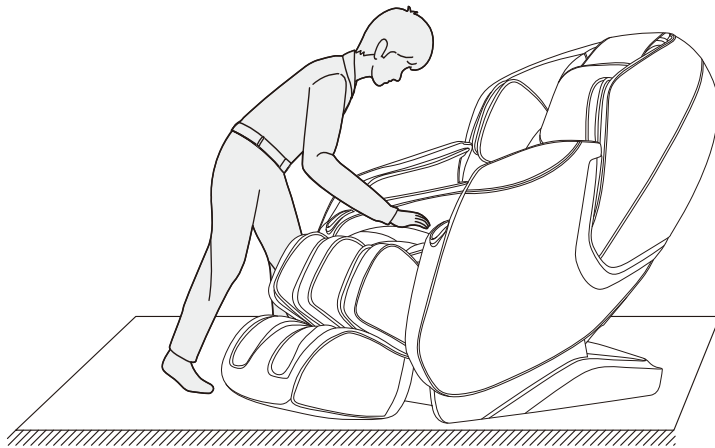

## Safety warning

### ⚠ Warning

Do not strive to pull out the control cable or power cord during standby or power-on state to avoid product damaged or electrocution accidents. Advise you unplug the controller cable and power cord and put away after you use the chair.

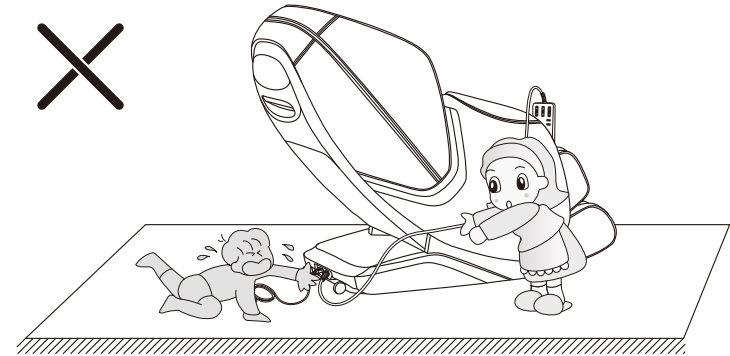

### ⚠ Warning

When start the zero gravity lying function, be sure to check whether there are children and pets under the bottom of the footrest and backrest, may cause the product damaged or personal injuries.

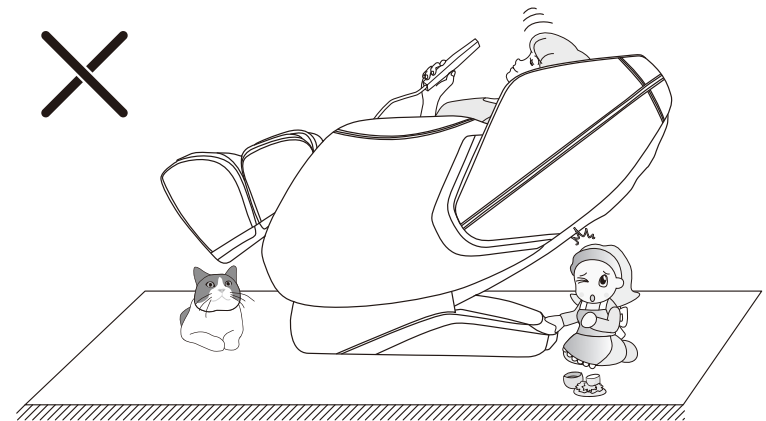

## Name and function of components

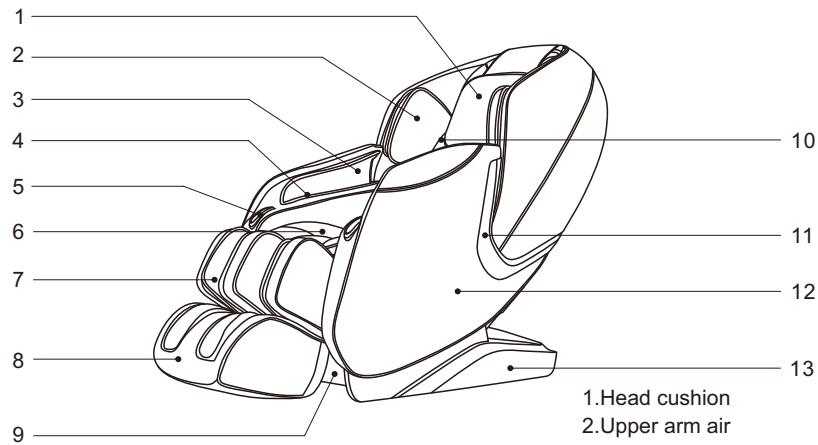

- 1.Head cushion
- 2.Upper arm air pressure component
- 3.Arm air pressure component
- 4.Salient massage with magnetic therapy
- 5.Remote controller and mobile phone holder
- 6.seat cushion
- 7.Leg rest frame
- 8.Foot rest frame
- 9.Calf retaining plate
- 10.Back cushion
- 11.Armrest decoration
- 12.Armrest
- 13.Side cover

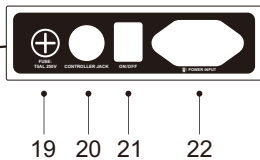
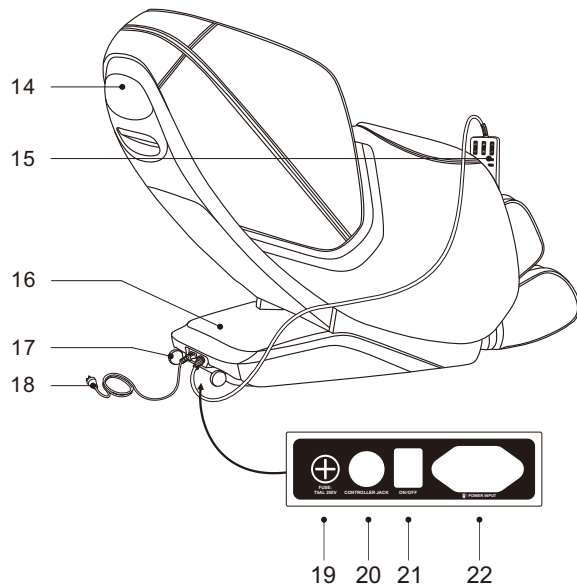

## Function

- Designed with a set of vertically movable, four wheel driven muted intelligent massage hands.
- There are five kinds of simulated massage techniques: shiatsu, kneading, tapping, knocking, kneading and tapping.
- Set with six kinds of characterized auto massage function: comfort, ease, full body, neck& shoulder, back & waist massage, stretch.
- It has the upper body manual massage function (area, fixed point, full back, neck shoulder, back waist, five massage parts selection, each massage technique speed can be adjusted in three steps. In the fixed point and partial module state, the massage ball can move up and down to adjust the massage point accurately. In the state of tapping, shiatsu and knocking massage, the width between the two kneading balls is adjustable with three levels: wide, medium and narrow..
- Air pressure massage function with three modes: Full body air pressure, arms air pressure, leg air pressure, with 3 intensity adjustable.
- With sole roller massage function
- The footrest can be extended to suit different leg lengths.
- The motor drives the footrest and the backrest synchronically and lay down automatically two regulatory functions.
- The backrest of the massage chair should be kept at least 275 mm away from the wall.
- Back heating function: The carbon fiber is used as the infrared heat.
- Placed a high-energy magnet at each of the left and right heels.
- In the left and right palm air bags, there is a salient massage with a magnetic massage function.
- Natural magnet is placed at the heel of the heel.
- The SL-type backrest track fits the human body curve, and the backrest is in a zero-gravity state when lying down.
- The chair will be reset when switch off. The massage hands will be restore as well.

## Method of usage

**Note: The specific displays refer to the actual object of this product!**

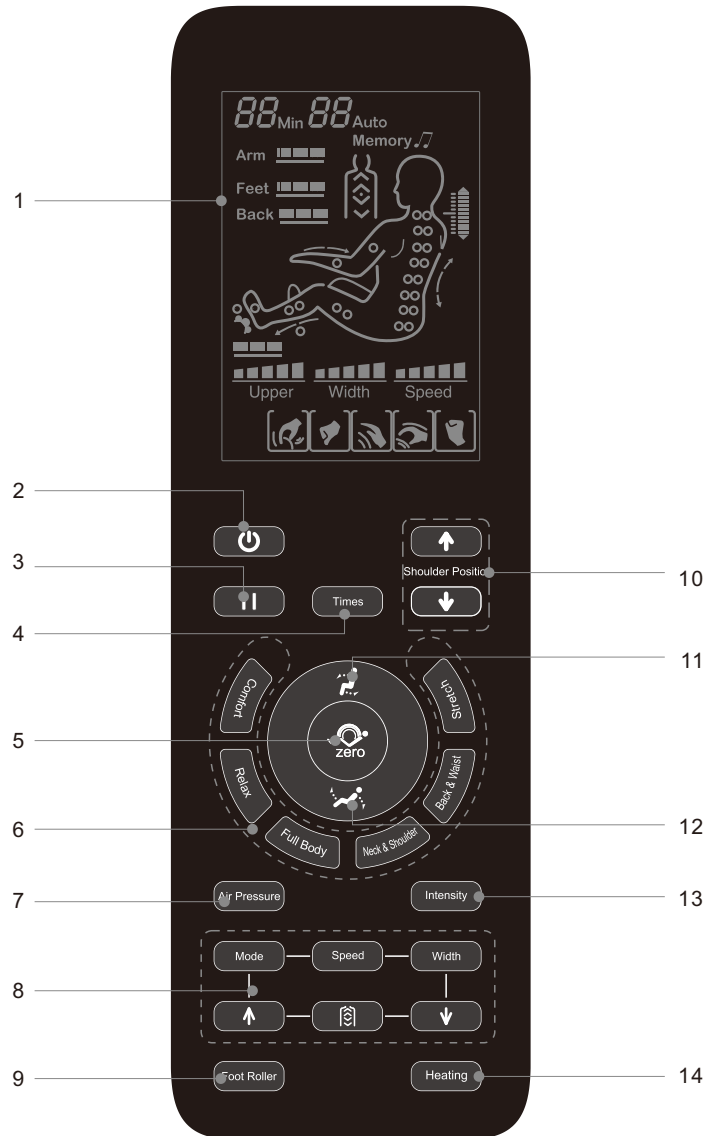

## Method of usage

- 1.LCD display:
  - Display all massage functions
- 2.Power switch:
  - Turn on or Turn off all massage functions.
- 3.Pause button:
  - Stop or start all massage functions..
- 4.Timing button
  - Time setting
- 5.Auto lying Button
  - There are three automatic lying position, choose your favorite one.
- 6.Auto massage Button
  - Please refer to page 10 of this manual for details.
- 7.Air pressure mode Button
  - Turn on/off the air pressure massage function (refer to page 11 of this manual for details).
- 8.Manual massage button
  - Please refer to page 10 of this manual for details.
- 9.Sole roller button
  - Turn on/off sole roller massage function
- 10.Shoulder adjust button
  - Make the adjustment on shoulder acupressure points.
- 11.Lifting button
  - Rise up the backrest and lower down the footrest.
- 12.Lying button
  - Lower down the backrest and rise up the footrest.
- 13.Air pressure intensity button
  - Make the adjustment on air pressure intensity.
- 14.Heating
  - Turn on/off heating massage function

## Method of usage

### 1. Switch power supply on



### 2. Start to massage

- ①. Press the power button to start massage.
- ②. The chair conduct a body scan and testing your shoulder position and massage point, waiting for detection to be completed
- ③. If the body scan deviates from the actual shoulder position, adjust the up and down buttons to the appropriate position. There are 10 levels to adjust, and you have 10 seconds to make the adjustment. After 10 seconds, enter in to massage automatically.

Button	Description	Display
	Move the massage balls upward to a suitable position	
	Move the massage balls downward to a suitable position	

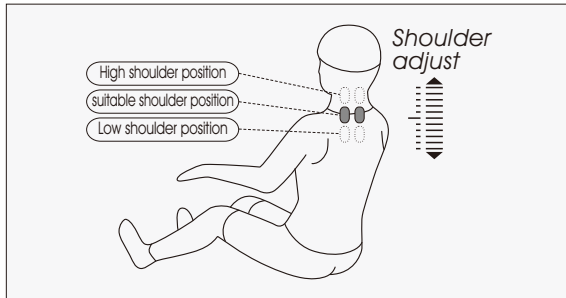

During the body scan process (the shoulder position adjustment icon will be displayed on the screen of the controller and sounds "DiDi", and then press the shoulder position up and down keys to adjust the shoulder position). You can also press any of the six automatic massage function keys (comfort, ease, full body, neck shoulder, back waist, stretch) and start massage (you can skip step 4 directly).

- ④. Choose massage function and start massage

## Method of usage

### · Features automatics massage









Function	Button	Description	Display
Features automatics massage		Loosen the muscles.	F1 Auto
		Deep-tissue massage throughout key acupressure points to relax the sore area.	F2 Auto
		Full body massage, relaxing the sore areas.	F3 Auto
		Focus on the neck and shoulder area	F4 Auto
		Focus on the back waist area.	F5 Auto
		The footrest and backrest lifting together, combined with air pressure massage to stretch the legs, remove fatigue, and recover your body.	F6 Auto

### · Upper body manual massage



Function	Button	Massage ball adjustment	Display
Massage		Shiatsu Speed, width	
		Kneading: Speed	
		Tapping: Speed, width	
		Kneading and tapping: speed	
		Knocking: Speed, width	
Speed		3 adjustable level	
Width		3 adjustable level	
Back stretch		The massage hand stay in fixed position	H0
		The massage hand will move up and down in a partial position	H1
		The massage hand will move up and down on full back	H2
		The massage hand will move up and down on back and shoulder area	H3
		The massage hand will move up and down on back and waist area	H4
		Massage position adjustment (in fixed point, partial mode, the massage position can be adjusted).	Massage hand move up
	Massage hands go down		

## Method of usage



### · Air pressure massage

Function	Button	Description	Display
Air pressure mode		Full air pressure: air pressure massage on arm, leg and foot.	Arm  Feet 
		Arm: Air pressure massage focus on arm.	Arm 
		Legs: Air pressure massage focus on leg and foot.	Feet 
Intensity		3 levels adjustable	Arm  Feet 



### · Foot roller manual massage function

Function	Button	Description	Display
Foot roller		The foot roller massage function turn on or off.	



### · Heating

Function	Button	Description	Display
Heating		Press this button to turn on/off the back infrared heating, and it will be warm after turning on 3 minutes.	

### · Pause/start massage button

Function	Button	Description	Display
Pause/Start		Press this button during the massage, all massage actions are stop immediately (the timer will continue to count down), and press this button again, all the massage will be resume.	

### · Backrest and calf position adjust

Function	Button	Description
Lifting button		Press and hold this button, it will raise the backrest and lower the footrest simultaneously, a "Di.Di sound indicate that it has reach the maximum position and stop. Press this button again while lifting, then immediately stop.
Lying button		Press and hold this button, it will lower the backrest and raise the footrest simultaneously, a "Di.Di sound indicate that it has reach the maximum position and stop. Press this button again while lifting, then immediately stop.
Automatic lying mode		When pressing this button, it will automatically place you into one position, total three position switch.

## Method of usage

### · Other manual functions

Function	Button	Description	Display
Timing		Timing adjustment, press one time, add 5 minutes, not more than 30 minutes. If it exceeds 30 minutes, it will return to 5 minutes.	20min

### 3. Turn off the power and stop massage.

- When pressing the power button during the massage, it will stop all the massage functions immediately, the backrest and footrest will go back to the default position. And when the massage time up, the massage hand will go back to the default position, all the massage function will stop, the backrest and footrest will not go back to the default position.
- Cut off the power of the whole machine. Figure (switch power off)

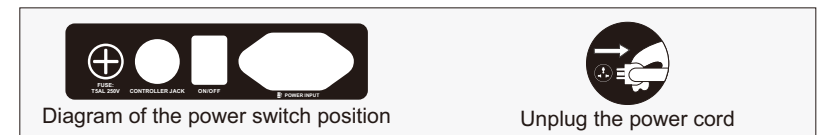

### 4. The calf installation.

1. After connecting the air hose and the wire harness on the calf and the massage chair, untie the fixed line belt and insert the connecting part into the frame. (Figure 1).
2. Place the calf fixing block on the two sides of the round tubes of the calf (Figure 2).

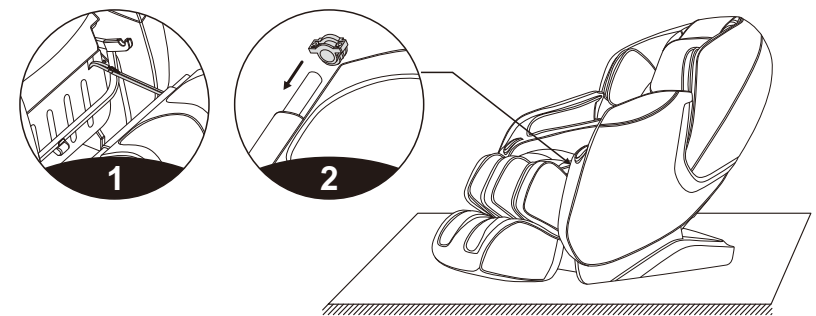



## Method of usage

3. Hang the calf of the fixed block on the massage chair frame hook (Figure 3).
4. Then use 4 (each side two pcs) M4 screws to fasten the calf to the massage chair, check whether there is any abnormality, whether the pipeline is folded or not, and finish the installation (Figure 4).

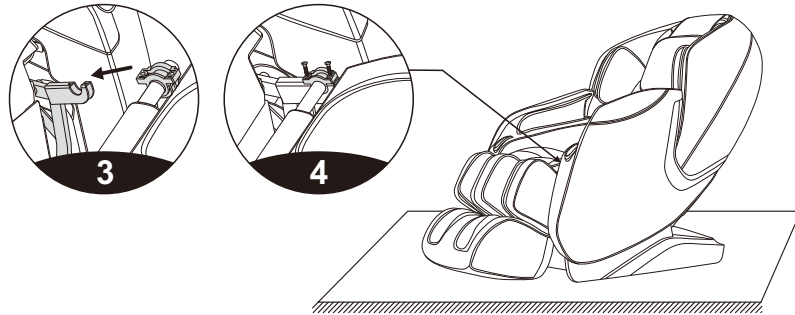

## 5. Head cushions and backrest pad's dismounting and use manual

- The head cushion allows you to control the intensity of the neck and shoulder massage. You can decide whether to use the head cushion (Recommend to use). The backrest cushion and the backrest is connected by zipper (1), head cushion and the backrest cushion connected by the Velcro as show in the illustration (2).

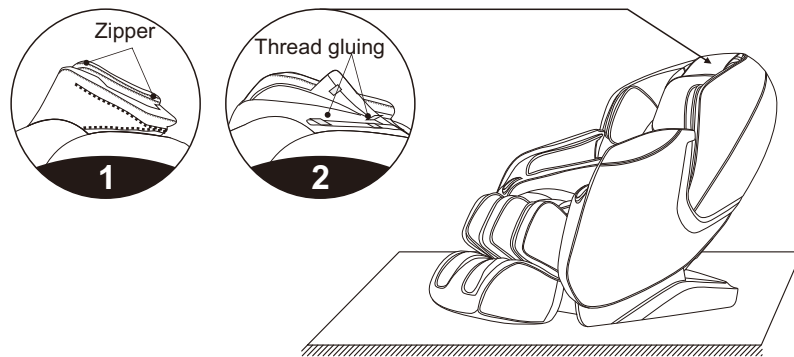

## Method of usage

### 6. Floor Protection

- Put the heavy massage chairs on the wood floor for a may damage the floor, so please place a carpet or other object to avoid this damage.

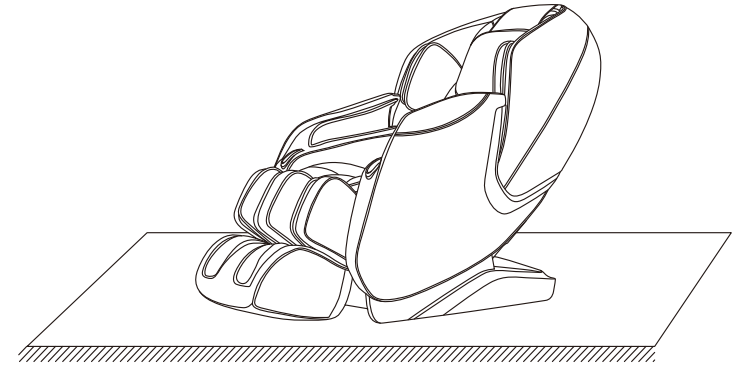

Caution: Do not move the chairs with its wheels on wood floor, rough ground or in a narrow space. Two people are required to lift the chair. During the lifting period, take the calf rest end sealing plate and backrest cover grooves as the force-bearing point(Please do not lift armrest directly.)

### 7. Method of movement

- Make sure that all wires are far above the ground, tilt the backrest backward to a certain degree (with the gravity center resting on the wheels), push the chair forward or backward with your hands and finally resume the chair to the normal position in a slow and gentle manner.

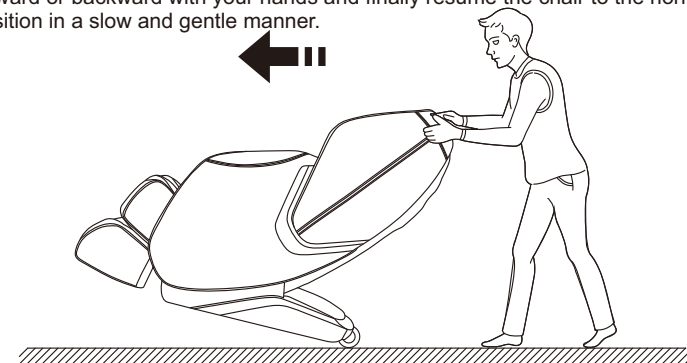

Note: During movement you must turn off the power first and then unplug the power cord and the controller cord.

## Method of usage

---

### 8.The distance from the wall

- When you place the massage chair, the backrest should always be kept at least 275mm away from the wall. If the backrest is too close to the wall, it will collide the wall and cause damage to the product when it lifting down.

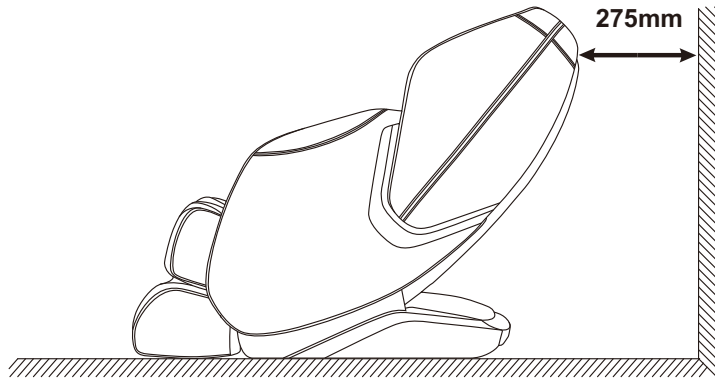

## Product specification

---

Model: A300

Configure: 1

Name: Massage Chair

Rated voltage: 110-120V~ 60Hz

220-240V~ 50Hz/60Hz

Rated power input:115W

Rated time: 20Min

Safety structure: Class I

Material introduction: PVC, PA, steel parts and electric & electron parts

MATERIAL	PU	LEATHER	CLOTH	WOOD